



TO-B0603BC-MYE **Surface Mount Device LED**

Features

- IC compatible.
- Compatible with automatic placement equipment.
- Compatible with infrared and vapor phase Reflow solder process.
- Top View TYPE.
- Package in 8mm tape on 7" diameter reel.
- Lead-Free Package (According to RoHS).

Package Dimensions

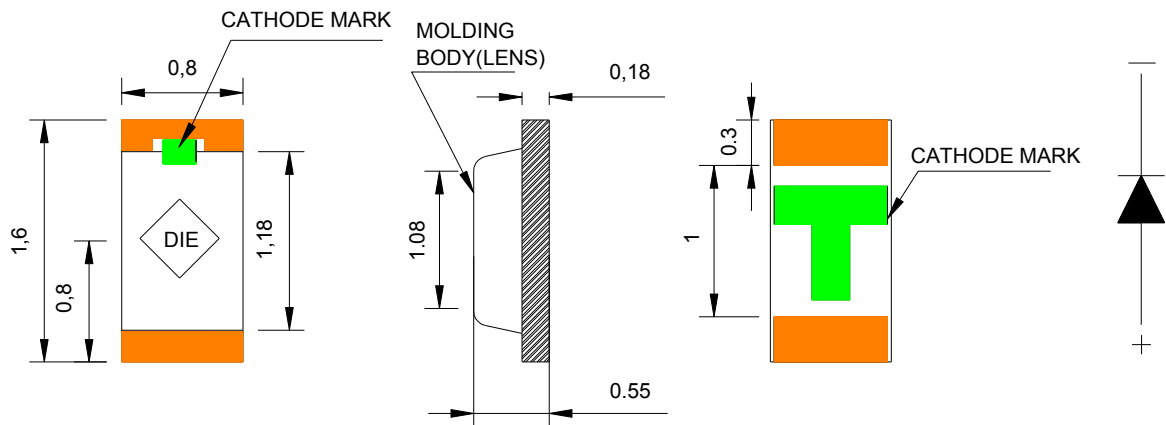

Note:

1. All dimensions are in millimeters.
2. Tolerance is ± 0.1 mm unless otherwise noted.



Absolute Maximum Ratings at $T_A=25^\circ\text{C}$

Parameter	Maximum Rating	Unit
Peak Forward Current (1/10 Duty Cycle, 0.1ms Pulse Width)	80	mA
Power Dissipation	75	mW
Continuous Forward Current	25	mA
Reverse Voltage	5	V
Operating Temperature Range	-55°C to +85°C	
Storage Temperature Range	-55°C to +105°C	
IR Reflow Soldering Profile For Lead Free Soldering	260°C	

Electrical / Optical Characteristics at $T_A=25^\circ\text{C}$

Parameter	Symbol	Min.	Typ.	Max.	Unit	Test Condition
Luminous Intensity	I_v	51		146	mcd	$I_F=20\text{mA}$
Viewing Angle	$2\theta_{1/2}$		130		deg	$I_F=20\text{mA}$
Dominant Wavelength	λ_d		590		nm	$I_F=20\text{mA}$
Spectral Line Half-Width	$\Delta\lambda$		15		nm	$I_F=20\text{mA}$
Forward Voltage	V_F		2.0	2.3	V	$I_F=20\text{mA}$
Reverse Current	I_R			10	μA	$V_R=8\text{V}$



BIN CODE LIST

Luminous Intensity		Unit: mcd@20mA	
Bin Code	Min	Max	
E1	51	66	
E2	66	86	
E3	86	112	
E4	112	146	

Tolerance on each Intensity Bin is $\pm 15\%$

Dominant Wavelength		Unit: nm@20mA	
Bin Code	Min	Max	
588590	588	590	
590592	590	592	
592594	592	594	
594596	594	596	

Tolerance for each Dominate Wavelength Bin is $\pm 1\text{nm}$



Typical Electrical / Optical Characteristics Curves

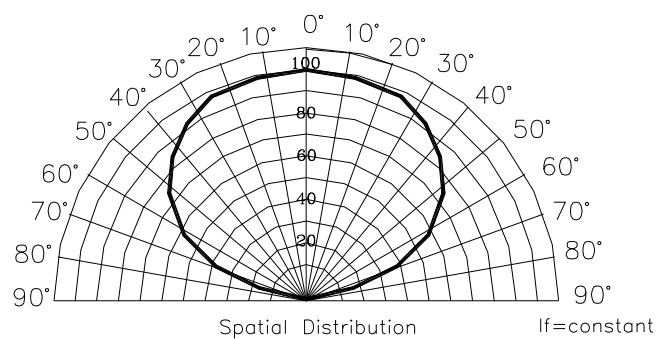
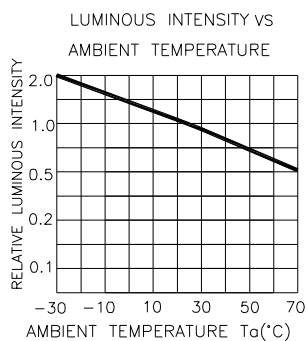
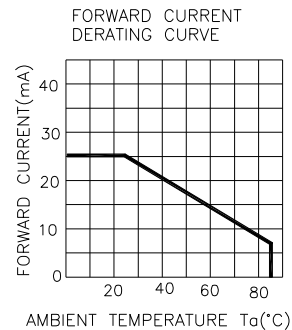
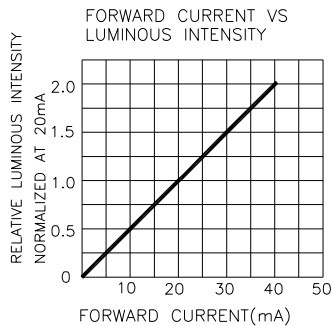
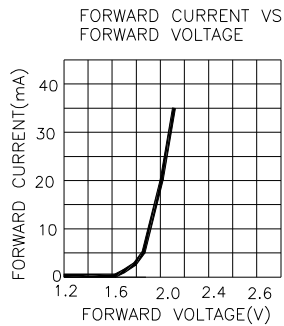
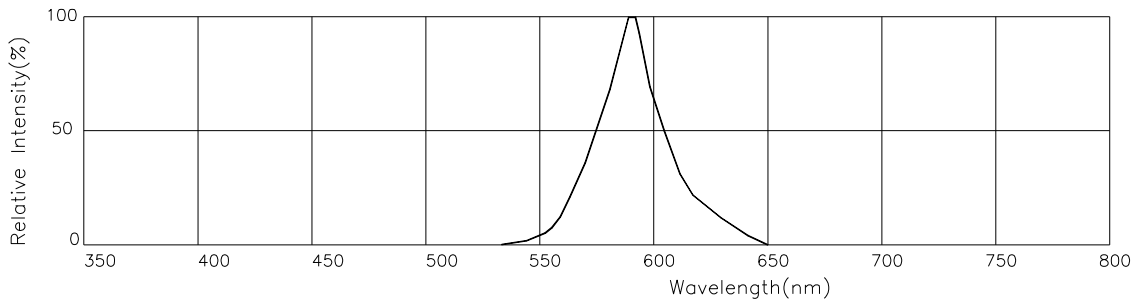



TAIWAN OASIS

Http://www.taiwanoasis.com.tw

Technical Data

Package Dimensions of Tape and Reel (Units: mm)

